

SCARA Robots i4L Series

Industry leading performance, flexibility and ease of use to address a wide range of applications

- 5kg payload, high inertia and high duty ratings enable the i4L to tackle more challenging processes with ease
- Compact built-in internal controller, out-of-the-box table or wall mounting and options for rear or bottom cabling reduces the physical area required and enables a customized installation
- High visibility, customizable, multi-colored LED dome light provides an intuitive visual indication of status
- Available in 350mm, 450mm, and 550mm reaches to accommodate a wide range of applications
- Easily integrates with the full line of Omron Automation products as well as 3rd party automation platforms



Specifications

Product		i4-350L		i4-450L		i4-550L			
Interface Panel Orientation		Rear	Bottom	Rear	Bottom	Rear	Bottom	Rear	Bottom
Part Number		RS4-2053002	RS4-2053102	RS4-2054002	RS4-2054102	RS4-2055002	RS4-2055102	RS4-2055004	RS4-2055104
Number of axes		4							
Reach (mm)		350		450		550			
Maximum Payload (kg)		5							
Quill Length (mm)				180				350	
Repeatability	XY (mm)	±0.01		±0.01		±0.01		±0.01	
	Z (mm)	±0.01		±0.01		±0.01		±0.01	
	Theta (deg)	±0.01		±0.01		±0.01		±0.01	
Joint Range	Joint 1 (deg)	±135							
	Joint 2 (deg)	±135		±148					
	Joint 3 (mm)			180				350	
	Joint 4 (deg)					±360			
Inertia Moment (Max.)	Joint 4 (kg m2)				0.05				
Maximum push force - vertical	Joint 3 (N)				150				
Joint Speeds	Joint 1 (deg/s)					456			
	Joint 2 (deg/s)					456			
	Joint 3 (mm/s)					800			
	Joint 4 (deg/s)					6000			
Cycle times*	Burst (s)	0.54				0.48			
	Sustained (s)	0.57		0.57				0.54	
	Blended Burst (s)**	0.45		0.42				0.38	
Power Requirements						24VDC: 5A 48VDC:15A			
Protection						IP20 / NEMA Type 1			
Environment Requirements	Ambient Temperature					5-40C			
	Humidity Range					5-90% non-condensing			
Weight (kg)		15.08		15.9		16.38		16.52	
Basic Configuration	Controller	Integrated iCS Controller							
	Communications Interface	Ethernet, Ethernet I/P							
	On-board I/O	8 outputs / 12 inputs (Primary Interface Panel) 4 outputs / 5 inputs (Secondary Interface Panel)							
	Pneumatic pass-through connections	Φ6mm × 2, Φ4mm × 1							
	Conveyor tracking input	2							
	RS-232C serial comm port	1							
	Programming Environment	ACE (Version 4.2 or higher)							
Optional Software Support	Vision Manager	Yes							
	Pack Manager	Yes							
Connectable Controller		IPC Application Controller							

*Adept cycle, in mm 25/305/25 (seconds, at 20C ambient) with 2.0kg payload

**Fast cycle, in mm (25/305/25) (seconds, at 20C ambient) with 2.0kg payload but with arc motion

Dimensions

i4-350L Dimensions

i4 350L Work Envelope

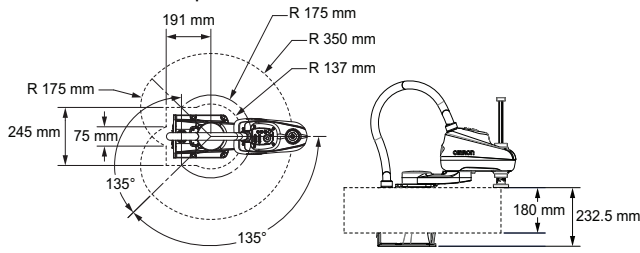

i4 450L Dimensions

i4 450L Work Envelope

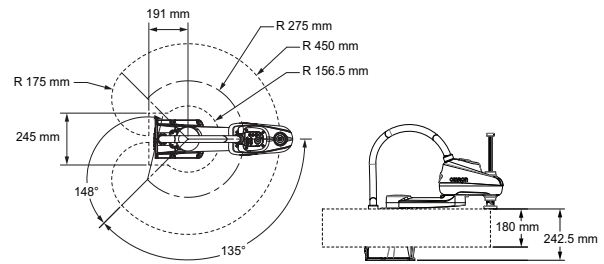

i4-550L Dimensions

i4 550L Work Envelope

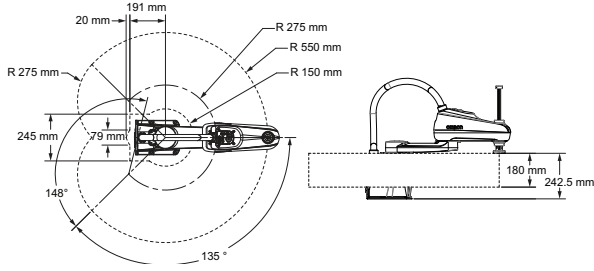

i4-550L Long Quill Dimensions

i4 550L Long Quill Work Envelope

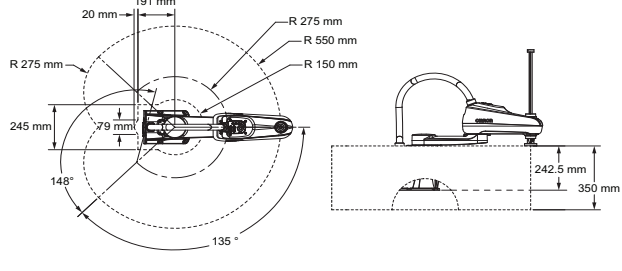

Mounting Options

Table Cable Exit Cut-Out Dimensions

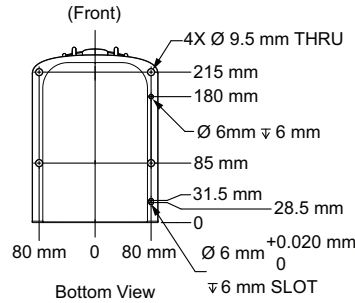
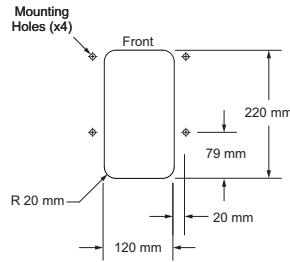
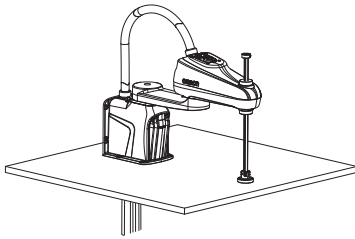

Wall Cable Exit Cut-Out Dimensions

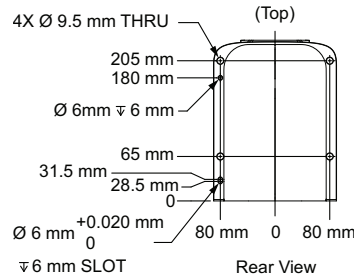
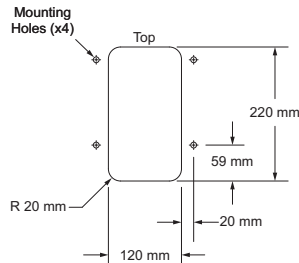
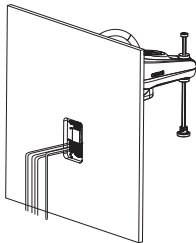

Flange

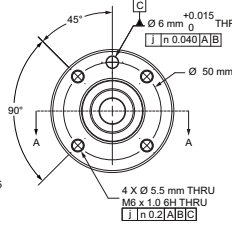
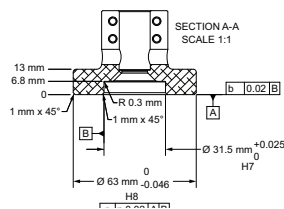

Front Panel

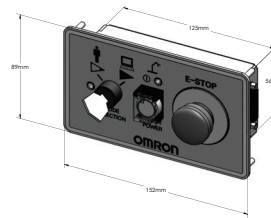

Robot Parts Code and Bundled Accessories

Product	i4-350L		i4-450L		i4-550L			
	Standard		Standard		Standard		Long-Quill	
Interface Panel Orientation	Rear Panel	Bottom Panel	Rear Panel	Bottom Panel	Rear Panel	Bottom Panel	Rear Panel	Bottom Panel
Part Number	RS4-2053002	RS4-2053102	RS4-2054002	RS4-2054102	RS4-2055002	RS4-2055102	RS4-2055004	RS4-2055104
Overview	SCARA Robot Arm + Integrated iCS Controller							
Bundled Accessories	XSYSTEM cable with jumpers, 1.8m/6ft (13323-100) Front Panel Kit (92546-10358)							

i4L Robot

RS4 - 2053002

(1) (2) (3) (4) (5) (6) (7) (8) (9)

No.	Item	Specifications	Symbol
(1)	Industrial Robots		R
(2)	Family	i4L	S4
(3)	Performance Level	Default	2
(4)	Version		0
(5)	Configuration	Standalone - with Ethernet Active	5
(6)	Size	350mm	3
		450mm	4
		550mm	5
(7)	Interface Panel Orientation	Rear	0
		Bottom	1
(9)	Quill Length	180mm	2
		350mm	4

Part Number List

Type	Part Number
i4-350L Rear Panel	RS4-2053002
i4-450L Rear Panel	RS4-2054002
i4-550L Rear Panel	RS4-2055002
i4-550L 350mm-Z Rear Panel	RS4-2055004
i4-350L Bottom Panel	RS4-2053102
i4-450L Bottom Panel	RS4-2054102
i4-550L Bottom Panel	RS4-2055102
i4-550L 350mm-Z Bottom Panel	RS4-2055104

Note: The purpose of this part number structure is to provide understanding of the meaning of specifications from the part number. Part numbers are not available for all combinations of code numbers.

OMRON AUTOMATION AMERICAS HEADQUARTERS • Chicago, IL USA • 847.843.7900 • 800.556.6766 • automation.omron.com

OMRON CANADA, INC. • HEAD OFFICE

Toronto, ON, Canada • 416.286.6465 • 866.986.6766 • automation.omron.com

OMRON ELECTRONICS DE MEXICO • HEAD OFFICE

Ciudad de México • 52.55.5901.4300 • 01.800.386.6766 • mela@omron.com

OMRON ELECTRONICS DE MEXICO • SALES OFFICE

San Pedro Garza García, N.L. • 81.12.53.7392 • 01.800.386.6766 • mela@omron.com

OMRON ELECTRONICS DE MEXICO • SALES OFFICE

Eugenio Garza Sada, León, Gto • 01.800.386.6766 • mela@omron.com

OMRON ELETRÔNICA DO BRASIL LTDA • HEAD OFFICE

São Paulo, SP, Brasil • 55 11 5171-8920 • automation.omron.com

OMRON ARGENTINA • SALES OFFICE

Buenos Aires, Argentina • +54.11.4521.8630 • +54.11.4523.8483
mela@omron.com

OTHER OMRON LATIN AMERICA SALES

+54.11.4521.8630 • +54.11.4523.8483 • mela@omron.com

Authorized Distributor:

Controllers & I/O

- Machine Automation Controllers (MAC) • Motion Controllers
- Programmable Logic Controllers (PLC) • Temperature Controllers • Remote I/O

Robotics

- Industrial Robots • Mobile Robots

Operator Interfaces

- Human Machine Interface (HMI)

Motion & Drives

- Machine Automation Controllers (MAC) • Motion Controllers • Servo Systems
- Frequency Inverters

Vision, Measurement & Identification

- Vision Sensors & Systems • Measurement Sensors • Auto Identification Systems

Sensing

- Photoelectric Sensors • Fiber-Optic Sensors • Proximity Sensors
- Rotary Encoders • Ultrasonic Sensors

Safety

- Safety Light Curtains • Safety Laser Scanners • Programmable Safety Systems
- Safety Mats and Edges • Safety Door Switches • Emergency Stop Devices
- Safety Switches & Operator Controls • Safety Monitoring/Force-guided Relays

Control Components

- Power Supplies • Timers • Counters • Programmable Relays
- Digital Panel Meters • Monitoring Products

Switches & Relays

- Limit Switches • Pushbutton Switches • Electromechanical Relays
- Solid State Relays

Software

- Programming & Configuration • Runtime